

Pump Your Needs.

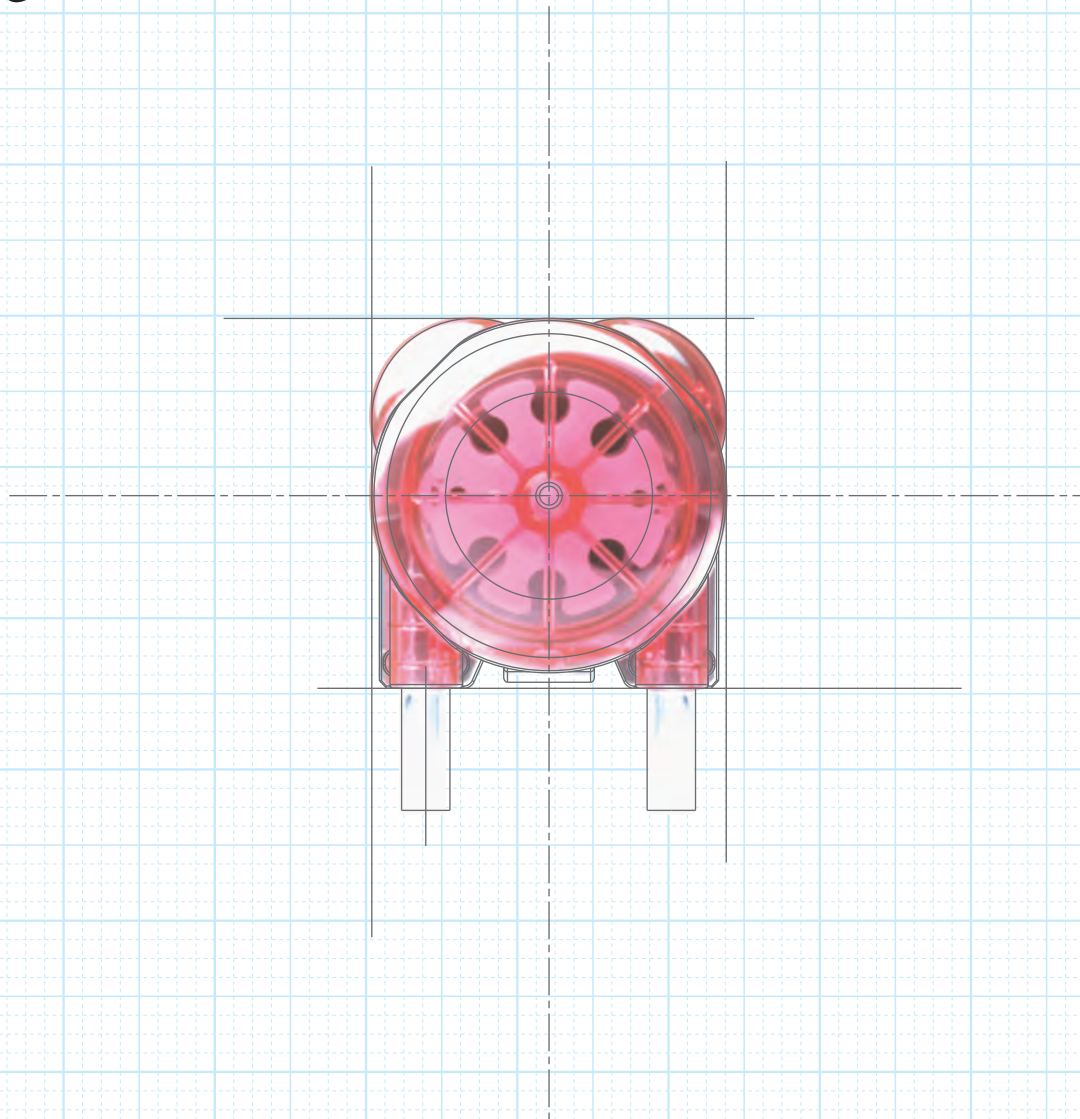

**WELCO's easy ordering system  
can match the best product to the customer's needs**

# **WPX1**









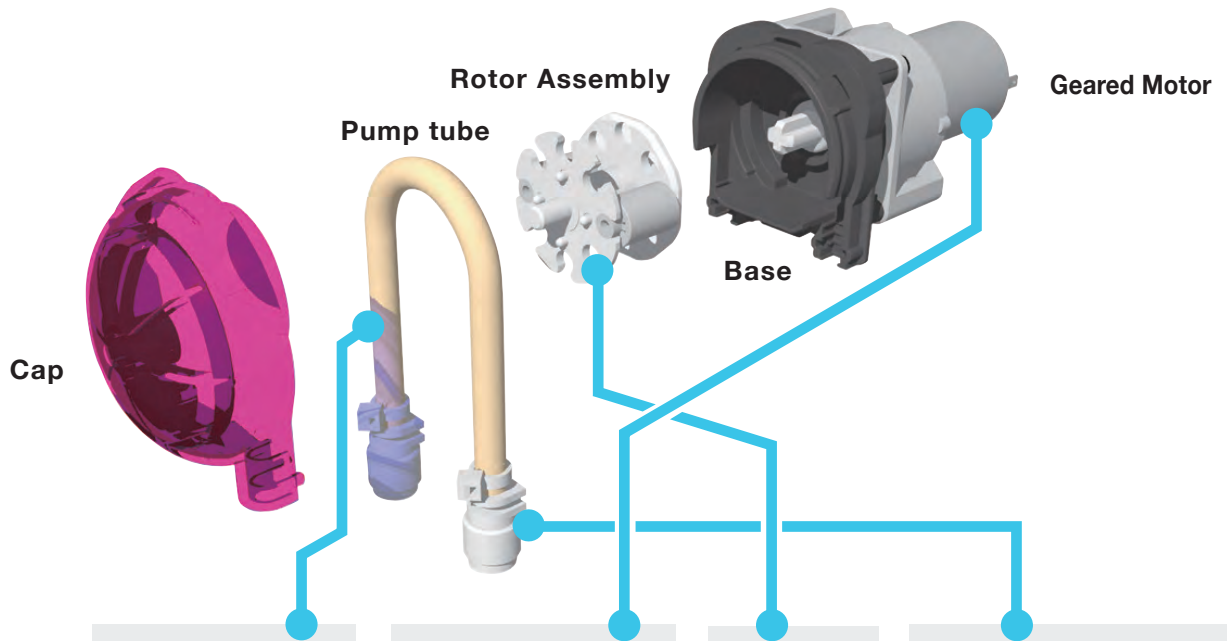

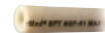

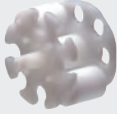

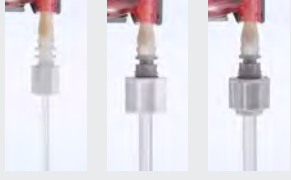

## **PERISTALTIC PUMP**

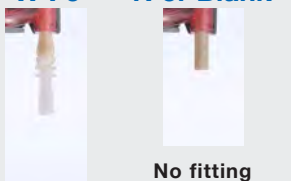
# **SELECTION GUIDE**

A specification of WELCO Peristaltic pumps can be determined by many combination of parts.

Please select each parts according to your requirement.





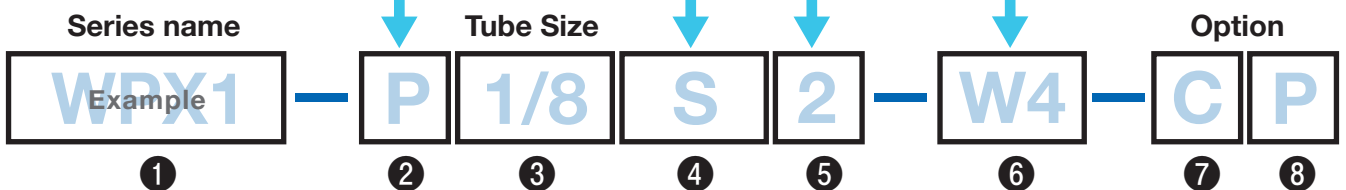





Pump tube type	Geared motor type	Number of rollers	Tube fitting type
<b>PHARMED BPT</b> <b>P</b> 	<b>S/M/L/DS/DM</b> 12/24VDC Brush motor 	<b>2: 2rollers</b> 	<b>W4</b> <b>WM3</b> <b>WM4</b> 
<b>TYGON A-60-G</b> (Norprene A-60-G) <b>N</b> 	<b>IG/ID/IF/JG/JD/JF</b> Low noise & Long life DC Brush motor 	<b>4: 4rollers</b> 	<b>J8</b> <b>J4</b> <b>W16</b> 
<b>TYGON A-60-F</b> (Norprene A-60-F) <b>NF</b> 	<b>FA/FB</b> Stepper motor 		<b>WT6</b> <b>N or Blank</b> 
<b>TYGON 3355/3350</b> <b>S</b> 	<b>CM/CD</b> Brushless motor 		No fitting
<b>Versilon F-5500-A</b> (Fluran F-5500-A) <b>F</b> 			
<b>Versilon 2001</b> (TYGON 2001) <b>U</b> 			
<b>TYGONS3 E-LFL</b> (TYGON E-LFL) <b>EL</b> 			
<b>TYGOPRENE XL-60</b> <b>XL</b> 			
<b>W TUBE</b> <b>W</b> 			

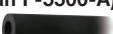

## 2 Pump tube type: Material (Selectable according to fluid type)



Tube type	Product Description	Regulatory compliance/meets
<b>PHARMED BPT</b> <b>P</b> 	<ul style="list-style-type: none"> <li>*Great resistant to general chemicals, acid, alkali and oxidizing agents</li> <li>*Compatible with virtually all commercial cleaners and sanitizers</li> <li>*Lasts up to 30 times longer than silicone tubes.</li> </ul>	USP Class VI
<b>TYGON A-60-G (Norprene A-60-G)</b> <b>N</b> 	<ul style="list-style-type: none"> <li>*Lasts and perform better than EPDM and other speciality rubber tubes</li> <li>*Ozone and UV Light resistant</li> <li>*Applicable to soap and disinfectant dispensing, printing ink transfer, and etc...</li> </ul>	-
<b>TYGON A-60-F (Norprene A-60-F)</b> <b>NF</b> 	<ul style="list-style-type: none"> <li>*Food process tube for critical processing applications in the food, dairy and cosmetic industries.</li> <li>*Compatible with virtually all commercial cleaners and sanitizers</li> <li>*Great resistant to general chemicals, acid, alkali and oxidizing agents</li> </ul>	FDA 21 CFR Part 177.2600 NSF 51 3-A
<b>TYGON 3355/3350</b> <b>S</b> 	<ul style="list-style-type: none"> <li>*High-performance and platinum-cured silicone tube</li> <li>*Ultra-smooth inner bore reduces potential for particle entrapment</li> <li>*Excellent fluid flow characteristics.</li> </ul>	FDA 21 CFR Part 177.2600 USP Class VI 3-A (3350 only)
<b>Versilon F-5500-A (Fluran F-5500-A)</b> <b>F</b> 	<ul style="list-style-type: none"> <li>*A proprietary fluorelastomer tube</li> <li>*Exellent resistance to corrosive chemicals, oils, fuels and solvents</li> <li>*Ozone and UV Light resistant</li> </ul>	-
<b>Versilon 2001 (TYGON 2001)</b> <b>U</b> 	<ul style="list-style-type: none"> <li>*Plasticizer-free chemical resistant tube.</li> <li>*Great resistant to a wide range of fluids that typically destroy PVC products</li> <li>*Applicable to soap and detergent dispensing, ink transfer, water purification lines, food, beverage and chemical transfer</li> </ul>	FDA 21 CFR Part 177.2600
<b>TYGONS3 E-LFL (TYGON E-LFL)</b> <b>EL</b> 	<ul style="list-style-type: none"> <li>*Non-DEGO tube for laboratory, Food &amp; Beverage and Biopharmaceutical Applications</li> <li>*Longest flex life in any clear Tygon tubes</li> <li>*Extremely low particle spallation for sensitive fluid applications</li> </ul>	FDA 21 CFR Part 177.2600 USP Class VI NSF-51
<b>TYGOPRENE XL-60</b> <b>XL</b> 	<ul style="list-style-type: none"> <li>*Alternative to silicones and PVC when longer pump tube life is required</li> <li>*Excellent resistance to a wide range of fluids, including acids and bases</li> <li>*Greatly reduce the risk of fluid contamination</li> </ul>	FDA 21 CFR Part 177.2600 NSF 51
<b>W TUBE</b> <b>W</b> 	<ul style="list-style-type: none"> <li>*Dual-wall tube which has excellent resistant to chemicals, acid, alkali.</li> <li>*Inner layer: Polyolefin Outer layer: Thermoplastic Elastomers</li> </ul>	-

Note: TYGON, Pharmed, Norprene, Fluran and Tygoprene, Versilon are manufactured by Saint-Gobain Group.

## 3 Pump tube type: Tube size (Selectable according to the tube material and number of rollers)

Model name (inner diameter)	<b>1/16</b>	<b>3/32</b>	<b>1/8</b>	<b>3/16</b>
Inner diameter	1.6mm (1/16")	2.4mm (3/32")	3.2mm (1/8")	4.8mm (3/16")
Available tube material	P	S / P	All type (of)	ALL type except for U / XL
Number of rollers	2 / 4	2 / 4	2 / 4	2 / 4

Caution: Tube type EL1/8", F3/16" cannot be used with four rollers due to its high hardness.

### Flow amount benchmark (flow amount per rotation)

Inside diameter of tube (inches)	1.6mm (1/16")		2.4mm (3/32")		3.2mm (1/8")		4.8mm (3/16")	
Number of rollers	2	4	2	4	2	4	2	4
WPX1 Flow amount (mL)	0.17	0.15	0.35	0.3	0.6	0.5	1.2	0.9

Caution: The above table describes the initial benchmark flow amounts during water suction. This may vary considerably depending on the tube type, use period, ambient temperature, and lot tolerances, etc. Measure the specifications with reasonable leeway.

4 Gear motor types



DC Brush Motor & Gear

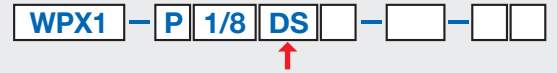

24VDC Brush Motor & Gear: Three types are selectable (low, medium and high speeds)

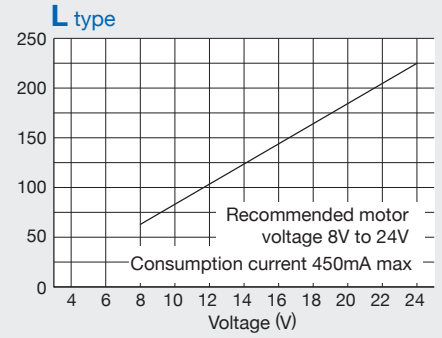
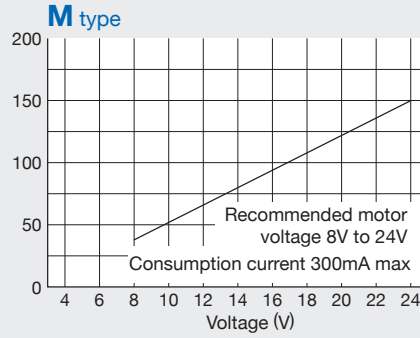
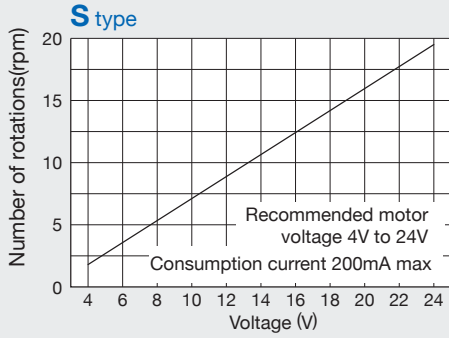

12VDC Brush Motor & Gear: Two types are selectable (low and medium speeds)

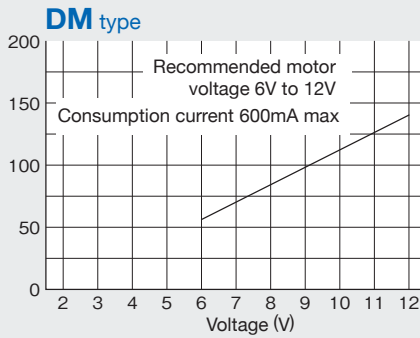
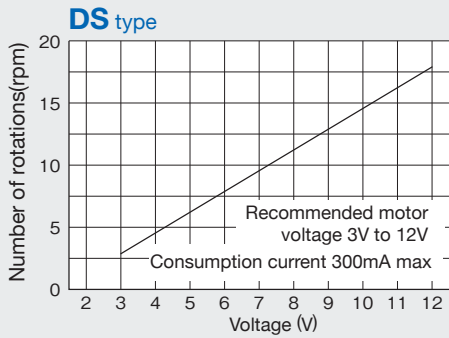

Motor wiring and terminal dimensions diagrams

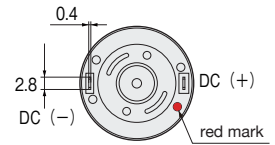

(unit: mm)

1. The consumption current described above is the value during normal operations. An approximately threefold inrush current occurs during rotation start up.
2. The RPM described above is the benchmark value when 100mNm load is applied to each motors. This may vary depending on tube type and operating conditions. Design an application with enough margin upon an evaluation under actual conditions.
3. Short circuit between terminals may occur due to end of motor life or short circuit between commutator slits by specific operating environment and condition. In order to prevent circuit burnout, please take protective measures such as using fuses.

Dimensions (unit: mm)

WPX1 - □□S  
WPX1 - □□DS

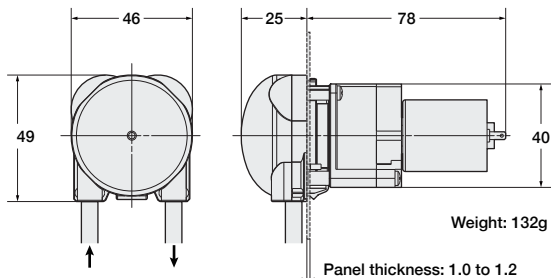

WPX1 - □□M  
WPX1 - □□L

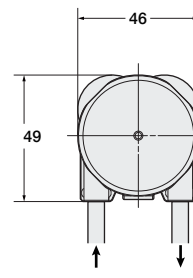

WPX1 - □□DM

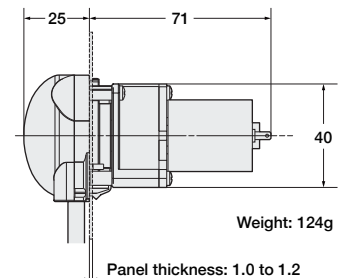

■ Cutting hole dimensions

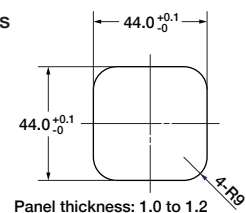



WPX1 - P 1/8 IG - - -

## High Performance DC Brush Motor & Gear

**24VDC Brush Motor & Gear:** Three types are selectable (low, medium and high speeds)

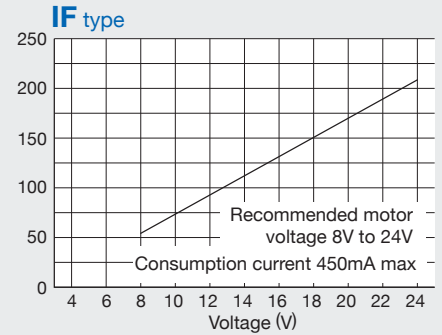
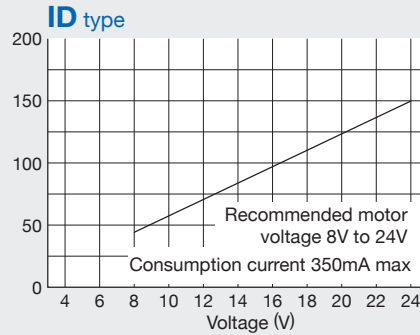
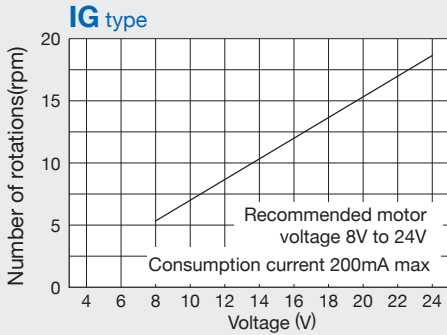

**12VDC Brush Motor & Gear:** Three types are selectable (low and medium speeds)

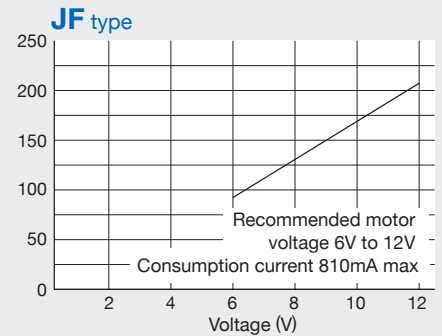
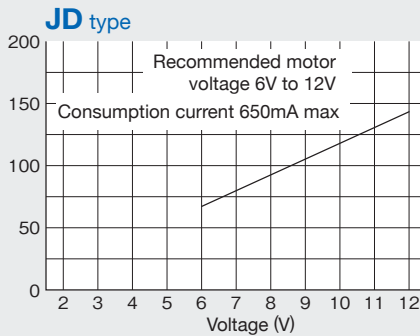
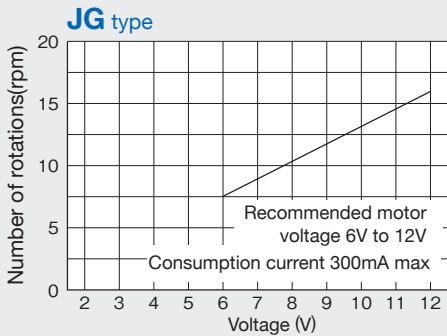

1. The consumption current described above is the value during normal operations. An approximately threefold inrush current occurs during rotation start up.
2. The RPM described above is the benchmark value when 100mNm load is applied to each motors. This may vary depending on tube type and operating conditions. Design an application with enough margin upon an evaluation under actual conditions.
3. Short circuit between terminals may occur due to end of motor life or short circuit between commutator slits by specific operating environment and condition. In order to prevent circuit burnout, please take protective measures such as using fuses.

### Dimensions (unit: mm)

WPX1 - □□ID  
WPX1 - □□J

WPX1 - □□IF  
WPX1 - □□JF

WPX1 - □□IG  
WPX1 - □□JG

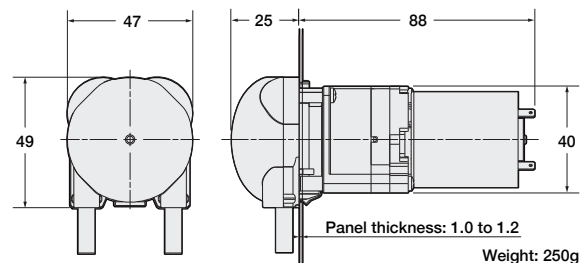
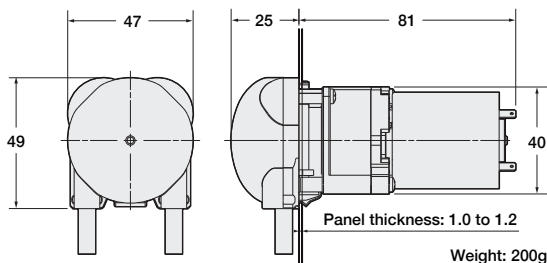

### Motor wiring and terminal dimensions diagrams

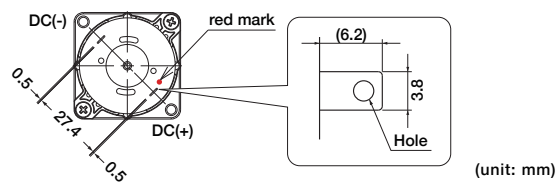

### ■Cutting hole dimensions

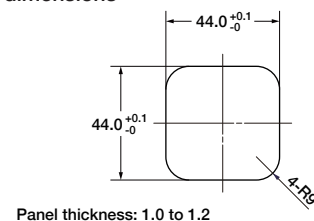



WPX1 - P 1/8 CM - - -

## DC Brushless Motor & Gear

### Geared motor Specification

Geared motor model	CM type	CD type
Configuration	Brushless motor & 1:64 Gear head	Brushless motor & 1:42 Gear head
Operation Voltage ※1	DC16V to DC24V	DC16V to DC24V
Current ※2	Less than 400mA	Less than 600mA
Motor Speed (rpm)	Approx. 47 to 70rpm at DC16 to 24V(100mNm Load)	Approx. 78 to 117rpm at DC16 to 24V(100mNm Load)
Direction of Rotation	CW	
Motor Rated Temperature	less than 70°C	
Motor lock protection	IC is integrated into the motor as thermal protection. The motor power shuts down automatically when the IC reaches a predefined temperature. There is no guarantee for recovery once it shuts down.	
	2sec TYP	
Life	5,000hr (Geared motor) ※Not a guaranteed value.	

※1.The lowest operation voltage may vary depending on the tube type, tube size, ambient temperature, etc. Please contact your sales representative to get help when you operate by lower voltage.  
 ※2.The consumption current described above is the value during normal operations. An approximately threefold inrush current occurs during rotation startup.

### Motor Wiring Information

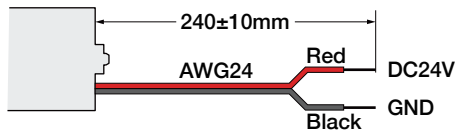

#### Circuit protection

There is no circuit protection against overvoltage and wrong connection. Do not apply surge voltages that exceed the rated voltage and not to connect to the incorrect polarity.

### Dimensions (unit: mm)

WPX1 - □□CM  
 WPX1 - □□CD

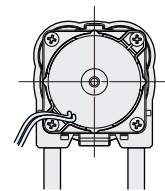
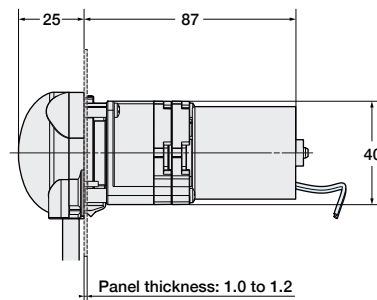
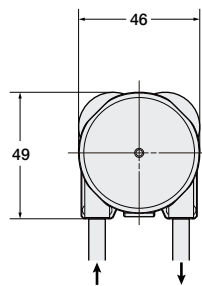

Weight: 230g

#### Cutting hole dimensions

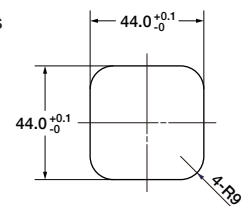



WPX1 - P 1/8 FB - - -

## Stepper Motor & Gear

Two types of stepper motors can be selected according to the application and the product series

### Geared motor Specification

Geared motor model	FB type	FA type
Configuration	Hybrid stepper motor & 1:64 Gear ratio	Hybrid stepper motor & 1:8 Gear ratio
Number of phases and motor type	2 phase/BI polar system	
Rated Voltage	1.92V	
Rated Current	0.8A/Phase	
Step Angle	0.0141°(Half step)	0.1125°(Half step)
Motor Speed (rpm)	0 to 20rpm	20 to 150rpm
Duty Ratio	Max. 50%	
Resistance	2.4Ω±10%	
Inductance	2.5mH	
Motor Insulation Class	B	
Motor Rated Temperature	less than 80°C	
Life	5,000hr (Geared motor) ※Not a guaranteed value.	

## Dimensions (unit: mm)

WPX1 - □□FA

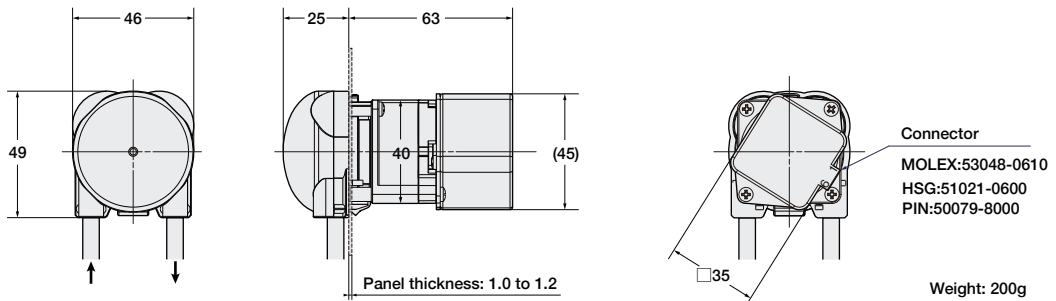

WPX1 - □□FB

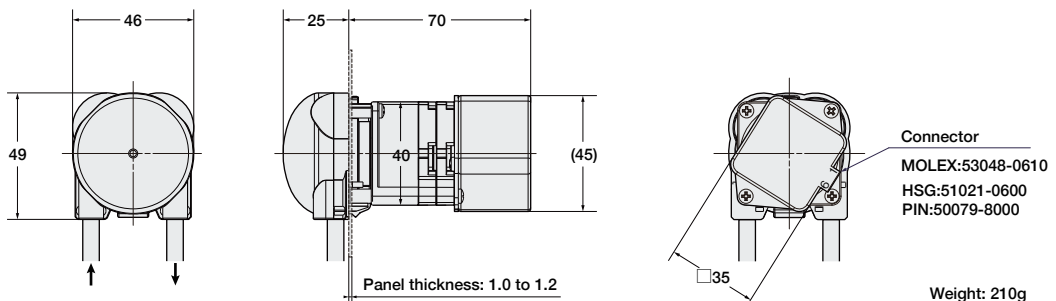

### ■Cutting hole dimensions

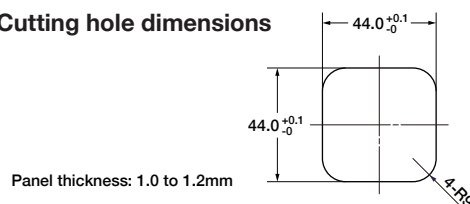

### ■BI POLAR Wiring Diagram

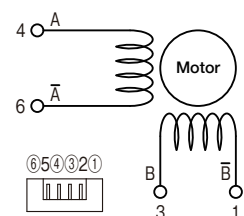

⑥ Tube fitting type: Varied lineup that is selectable according to requirements

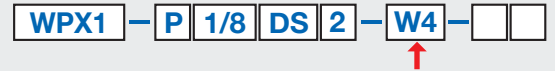

**W4**

- Connectable hose sizes (OD)  
1/4"(6.4mm) or 6mm
- Available Pump tube sizes & Pump series  
1/8"(3.2mm), 3/16"(4.8mm)

Fitting consists of compression nut, sleeve and insert. Supports various hose hardnesses.



**WM3**

- Connectable hose sizes (OD)  
3mm
- Available Pump tube sizes & Pump series  
1/16"(1.6mm), 3/32"(2.4mm), 1/8"(3.2mm)

Fitting consists of compression nut and sleeve. Supports various hose hardnesses. Nut and sleeve will vary according to hose size.



**WM4**

- Connectable hose sizes (OD)  
4mm
- Available Pump tube sizes & Pump series  
1/16"(1.6mm), 3/32"(2.4mm), 1/8"(3.2mm)

Fitting consists of compression nut and sleeve. Supports various hose hardnesses. Nut and sleeve will vary according to hose size.



**J8**

- Connectable hose sizes (OD)  
1/8"(3.2mm) (Nylon or Polyethylene)
- Available Pump tube sizes & Pump series  
3/32"(2.4mm), 1/8"(3.2mm)

Nut and sleeve are integrated. Excellent workability. Suitable for polyethylene, nylon and other plastic hoses.



**J4**

- Connectable hose sizes (OD)  
1/4"(6.4mm) (Nylon or Polyethylene)
- Available Pump tube sizes & Pump series  
1/8"(3.2mm), 3/16"(4.8mm)

Nut and sleeve are integrated. Excellent workability. Suitable for polyethylene, nylon and other plastic hoses.



**W16**

- Connectable hose sizes (OD)  
6mm (Nylon or Polyethylene)
- Available Pump tube sizes & Pump series  
1/8"(3.2mm), 3/16"(4.8mm)

Nut and sleeve are integrated. Excellent workability. Suitable for polyethylene, nylon and other plastic hoses.



**WT6**

- Connectable hose sizes  
6mm (Note: ID size)
- Available Pump tube sizes & Pump series  
1/8"(3.2mm), 3/16"(4.8mm)

Barbed type. Inserted directly into hose and used.



**N or Blank**

- Connectable hose sizes (OD)  
N/A
- Available Pump tube sizes & Pump series  
1/16"(1.6mm), 3/32"(2.4mm), 1/8"(3.2mm), 3/16"(4.8mm)

No fitting. For the case in which a customer connects their own original fitting, or when using a special length pump tube.  
Note: If the pump tube has a large diameter, the flow rate tolerance should be increased.



## 7 Color variation

A 5-color lineup that can be classified for use according to the type of liquids used

WPX1 - P 1/8 DS 2 - W4 - B

**B:** Blue      **G:** Green      **C:** Clear      **R:** Red      **Y:** Yellow      **UV:** Black (Special order item)

## 8 Using an optional panel

There is also a lineup of panels to which the pump can be easily mounted

WPX1 - P 1/8 DS 2 - W4 - B P

**P** = with bracket  
**N** or **Blank** = without bracket

■ Option bracket dimensions (unit: mm)

Thickness: 1.2  
Material properties: SUS304

## General specifications

Recommended installation height	2.0m max
Liquid temperature range	5 to 50°C (41°F to 122°F)
Specified environment temperature range	0 to 50°C (32°F to 122°F)
Specified ambient humidity range	20% to 80% (with no condensation)
Certifications & Approvals	

### ⚠ Precautions

- When selecting a tube, the customer should perform a verification test to verify the chemical suitability according to the usage environment and the intended application.
- Regardless of the pump tube type, the phenomenon of peeling from inside of the tube starts with small amounts.
- This product was not designed for medical use. Do not use for medical applications.
- This product is not waterproof. If using in water-filled environments, design to protect against water.
- Numerical data listed in this catalog reflect conditions measured over short periods of time. Their accuracy for long-term use is not assured.
- There is a tendency for the flow rate to increase until the tube becomes acclimated, and even among the same model, different lots may have different flow rates within the specified tolerances. Also, the rotating speed of the DC motor may fluctuate depending on the load conditions and changes in the motor temperature. During the design stage, be sure to select a motor with ample capacity.